

P-channel Enhancement Mode Power MOSFET

FEATURES

- PWM applications
- Load switch
- Power management

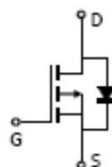

MAXIMUM RATINGS (TA=25°C unless otherwise noted)

Symbol	Parameter	Value	Units
V _{DS}	Drain-Source voltage	-20	V
V _{GS}	Gate-Source voltage	±12	V
I _D	Drain current	-3	A
P _D	Power Dissipation	1	W
T _J	Junction Temperature	150	°C
T _{stg}	Storage Temperature	-55-150	°C

ELECTRICAL CHARACTERISTICS (T_{amb}=25°C unless otherwise specified)

Parameter	Symbol	Test conditions	MIN	TYP	MAX	UNIT
Drain-Source Breakdown Voltage	V _{(BR)DSS}	V _{GS} =0V, I _D =-250uA	-20			V
Gate-Threshold Voltage	V _{th(GS)}	V _{DS} = V _{GS} , I _D =-250 uA	-0.4	-0.65	-1	V
Gate-body Leakage	I _{GSS}	V _{DS} =0V, V _{GS} =±12V			±100	nA
Zero Gate Voltage Drain Current	I _{DSS}	V _{DS} =-19V, V _{GS} =0V			-1	uA
Drain-Source On-Resistance	r _{DS(ON)}	V _{GS} =-4.5V, I _D =-3.0A		50	70	mΩ
		V _{GS} =-2.5V, I _D =-2.0A		70	90	mΩ
Forward Trans conductance	g _{fs}	V _{DS} =-5V, I _D =-1.0A	6			s
Dynamic Characteristics						
Input Capacitance	C _{iss}	V _{DS} =-10V, V _{GS} =0V, f=1MHz		405		pF
Output Capacitance	C _{oss}			112		
Reverse Transfer Capacitance	C _{rss}			89		
Switching Capacitance						
Turn-on Delay Time	t _{d(on)}	V _{DD} =-10V, R _L =2.9Ω , V _{GS} =-4.5V R _{GEN} =10Ω		11		nS
Turn-on Rise Time	t _r			35		nS
Turn-off Delay Time	t _{d(off)}			30		nS
Turn-off Fall Time	t _f			10		nS
Total Gate Charge	Q _g				9.0	
Gate-Source Charge	Q _{gs}	V _{DS} =-10V, I _D =-2.5A, V _{GS} =-4.5V,		1.0		nC
Gate-Drain Charge	Q _{gd}			2.5		nC
Drain-Source Diode Characteristics						
Diode Forward Voltage	V _{SD}	V _{GS} =0V, I _D =-3A			-1.2	V
Diode Forward Current	I _S				-3.0	A

Typical Characteristics

WPM2341

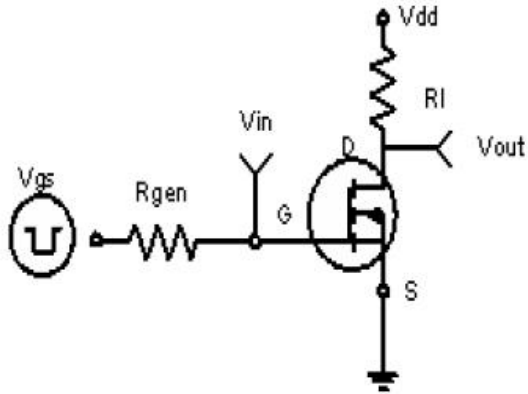

Figure 1: Switching Test Circuit

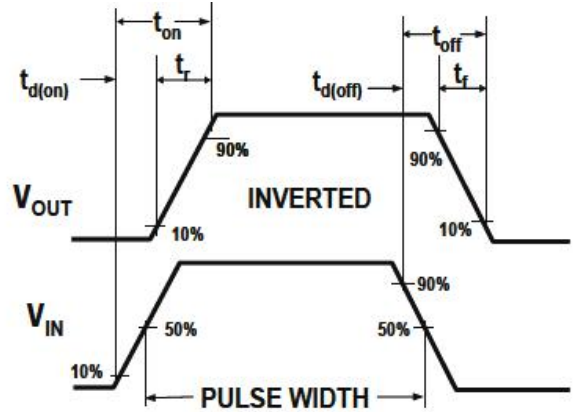

Figure 2: Switching Waveforms

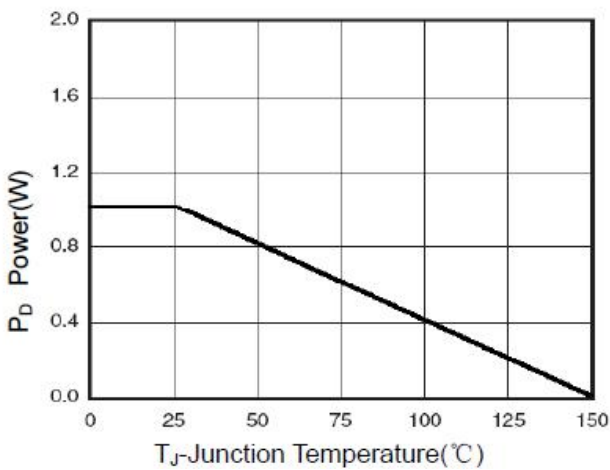

Figure 3 Power Dissipation

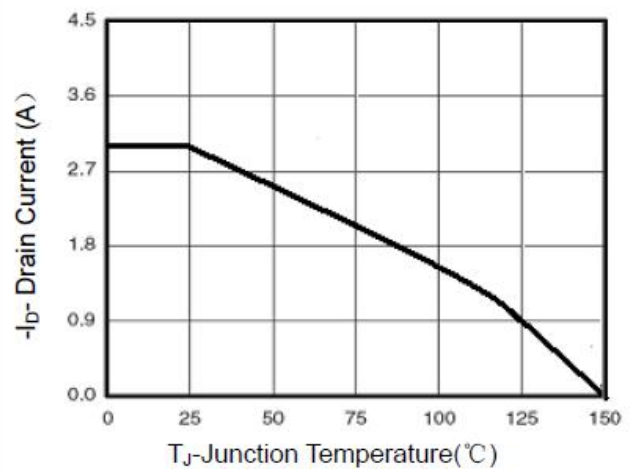

Figure 4 Drain Current

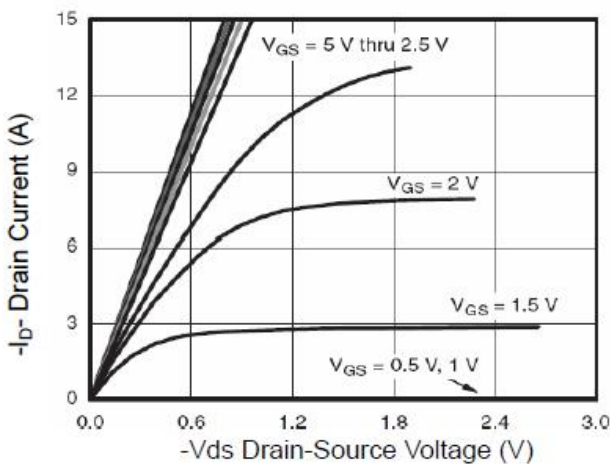

Figure 5 Output Characteristics

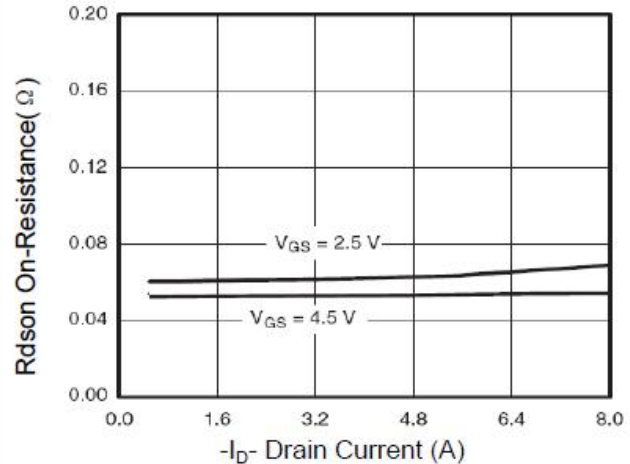

Figure 6 Drain-Source On-Resistance

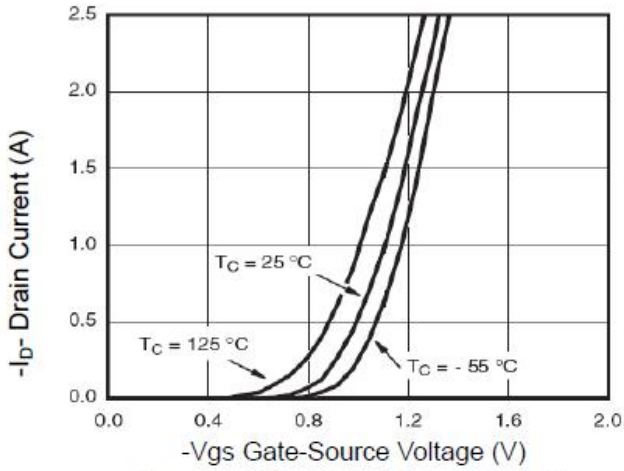

Figure 7 Transfer Characteristics

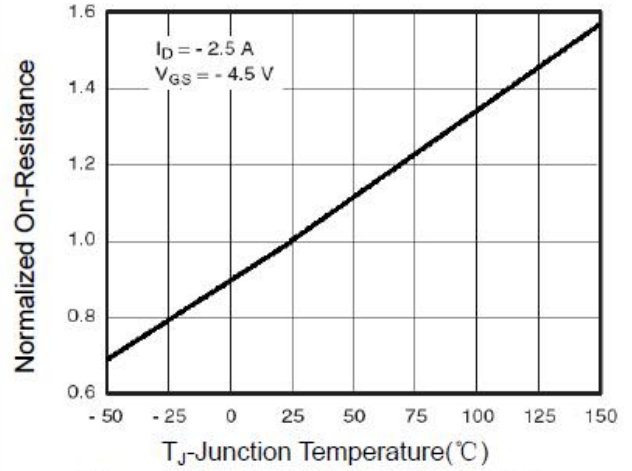

Figure 8 Drain-Source On-Resistance

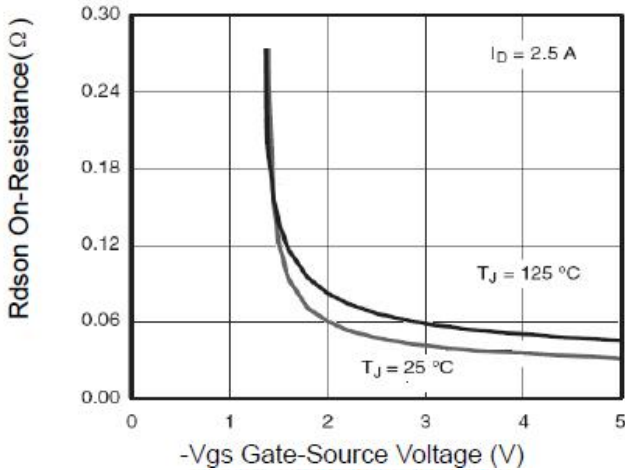

Figure 9 Rdson vs Vgs

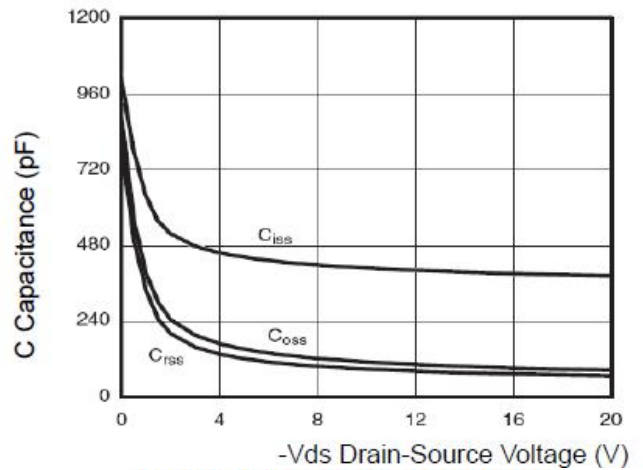

Figure 10 Capacitance vs Vds

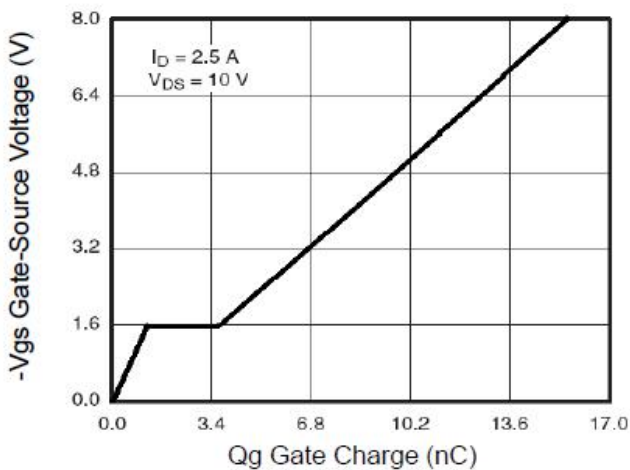

Figure 11 Gate Charge

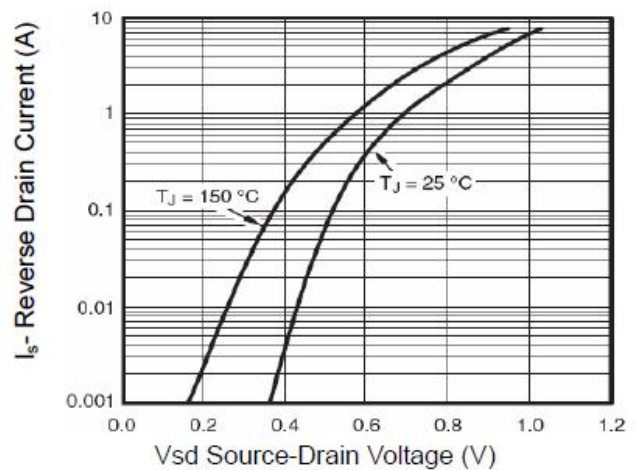
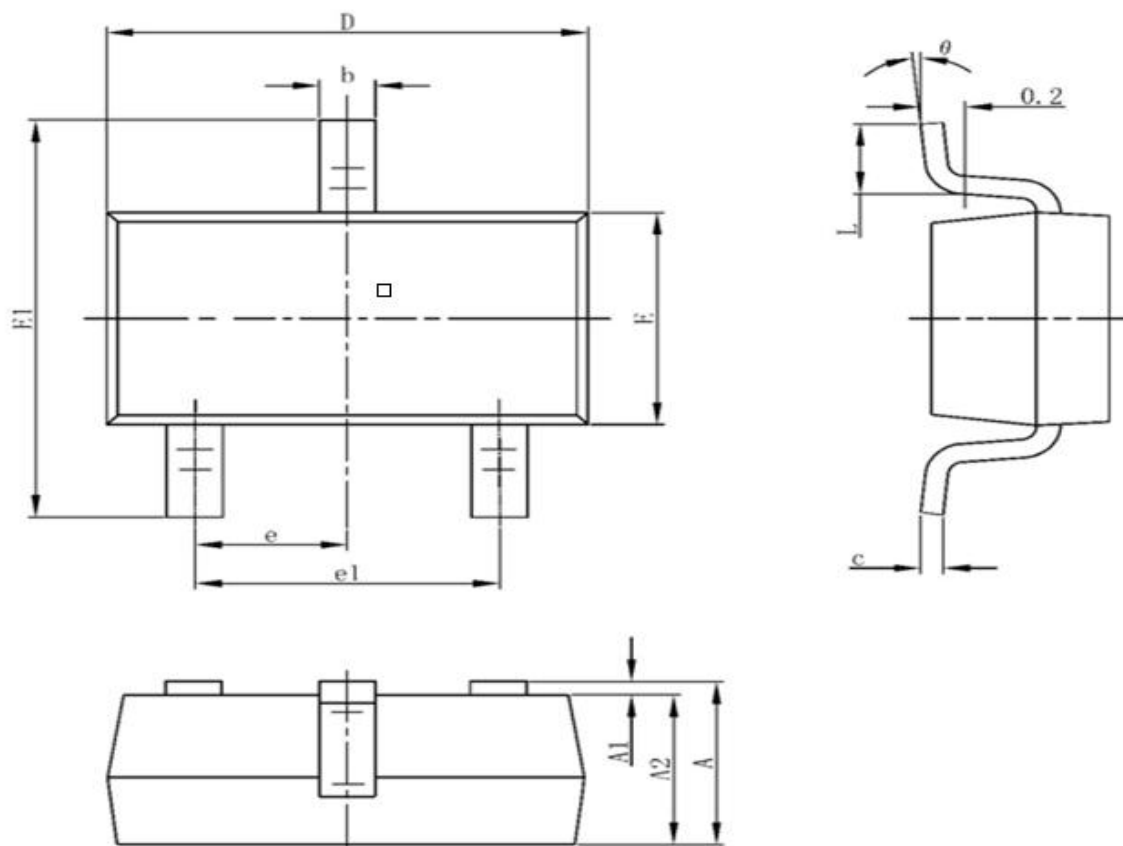

Figure 12 Source- Drain Diode Forward

SOT-23 PACKAGE OUTLINE DIMENSIONS

UNIT(mm)

Symbol	MIN	TYP	MAX
A	0.90		1.15
A1	0.01		0.15
A2	0.90		1.05
b	0.30		0.50
c	0.08		0.15
D	2.80		3.00
E	1.20		1.40
E1	2.25		2.55
e		0.95	
e1	1.80		2.00
L	0.30	0.4	0.50
L1	0.50	0.55	0.60
θ	0°		8°